



ZHIYUN

CRANE 2

User Guide

Contents

- Packing List 1
- Get to Know Crane 2 3
- Preparing and Charging the Batteries 5
- Installation 8
- Balance Adjustment 11
- How to Use 15
- APP Operations 30
- Calibration and Firmware Upgrade 31
- Usage of Main Accessories 36
- Product Specifications 42
- Disclaimer and Warning 43
- Warranty Terms 50
- Warranty Card 52
- Contact Card 53

Packing List

The product package comes with the following items. In case that any item is found missing, please contact ZHIYUN or your local selling agent.

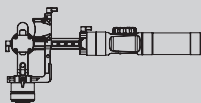

Crane 2 Three-axis
Gimbal Stabilizer

1

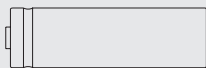

18650 Li-ion Battery

3

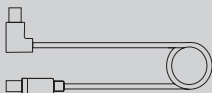

Canon Camera
Control Cable
ZW-Mini-002

1

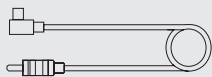

Panasonic Camera
Control Cable
ZW-CTIA-002

1



Micro USB Cable

1

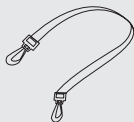

Shoulder Strap

1

Packing List

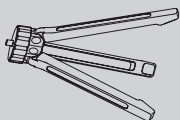

Tripod

1

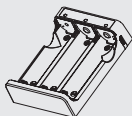

Battery Charger

1

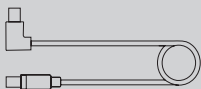

Canon Camera
Control Cable
ZW-Micro-002

1

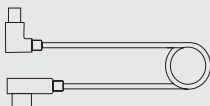

Sony Camera
Control Cable
ZW-MULTI-002

1

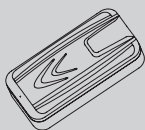

Storage Case

1



User Guide

1

Get to Know Crane 2

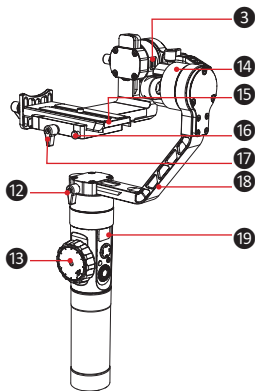
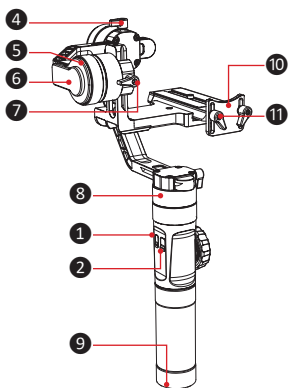

- 1 Micro USB port
- 2 DC 8.0 V Power Outlet
- 3 Camera Control Interface
- 4 Thumb Screw
- 5 Tilt Axis Motor
- 6 Horizontal Arm
- 7 Thumb Screw
- 8 Pan Axis Motor
- 9 1/4"-3/8" Threaded Hole
- 10 Lens Support
- 11 Camera Mounting Screw
- 12 Thumb Screw
- 13 Follow Focus Controller
- 14 Roll Axis Motor
- 15 Quick Release Plate
- 16 Safety Lock
- 17 Mounting Plate Thumb Screw
- 18 Vertical Arm
- 19 Control Panel (see more on Page 15)

Crane 2 Interface Description

Port	Output Voltage	Input Current	Function	Note
① Micro USB	∕	∕	The Micro USB port can only be used for firmware upgrade, and can neither be used for power input nor output.	∕
② DC 8.0 V Power Output	8V	2A	The DC 8.0 Power Output outlet can be used for charging cameras like Canon 5D series (see more on page 27 - DC 8.0 V Power Outlet Usage Description)	∕
③ Camera Control Interface	5V	1A	1. The camera control interface is connectable to camera control cable (see more on page 10 - ZHIYUN Camera Control Cable Description) 2. It can also be used as a USB charging port for Sony mirrorless cameras.	Canon, Nikon and Panasonic Cameras do not support USB charging.

For the first use of Crane 2, please use the dedicated charging device contained in the package to fully charge and activate the batteries to ensure the normal use of the product.

Charger & Battery Description

Charger Specifications

Name: 18650*3 Li-ion battery charger

Model: ZC-18650-3

Input: 5V \equiv 2400mA

Output: 4.2V \equiv 800mA*3

- Shines solid RED light when charging.
- Shines BLUE light when fully charged.

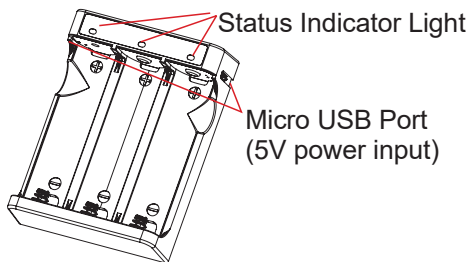

Battery Specifications

Name: 18650 Li-ion battery

Model: IMR 18650

Capacity: 2000mAh

Voltage: 3.7V

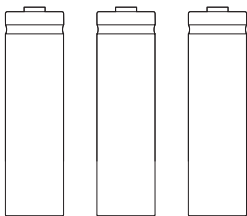

■ Notice:

1. Please read the disclaimer and warning herein as well as the description on the battery label carefully before using the batteries.
2. The ZC-18650-3 charger is for charging ZHIYUN's IMR 18650 Li-ion Battery only. Do not charge batteries of other models or brands, otherwise it may lead to accident.

⚠ Please use and charge batteries provided or approved by ZHIYUN only. ZHIYUN will not take any responsibility for explosion, fire and/or accidents caused by non-ZHIYUN batteries.

Charging Procedure

1. Insert the batteries into the charger in the right direction (positive/negative end) accordingly.
2. Connect the charger to the adapter via the Micro USB cable.
3. Plug the adapter into the power outlet to start charging.

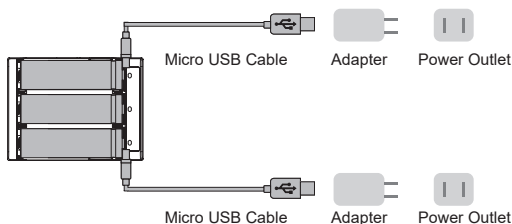

- 💡 1. There is a Micro USB 5V power input port on both sides of the charger, which supports one adapter or two adapters charging simultaneously (faster).

2. The simultaneous charging with two adapters may fail under the condition of insufficient power supply (like when the current of adapter is below 1000mA); Adapter with higher current capacity is recommended.

3. The USB Port along side the stabilizer does not support charging to batteries.
- ⚠️ 1. Please use qualified standard 5V/≥2000mA adapter for battery charging; Charging time depends on the maximum input current of the adapter.

2. The stabilizer comes standard with three high-discharge-rate dedicated batteries. Please use and charge batteries provided or approved by ZHIYUN only.

3. Please make sure all three batteries are fully charged. Either under charged battery can lead to the failure of the stabilizer.

Battery Installation

Unscrew the battery compartment and insert the three IMR 18650 batteries in the right direction (positive/negative end), then tighten the battery compartment.

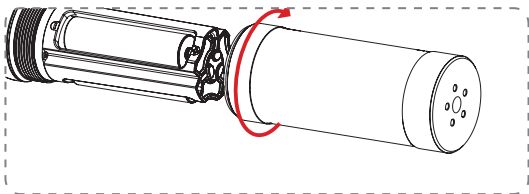

⚠ Please use and charge batteries provided or approved by ZHIYUN only, in case of accidents.

Tripod

Get the tripod ready and tighten it to the 1/4"-3/8" threaded hole at the bottom of the stabilizer, then unfold the tripod on a flat surface.

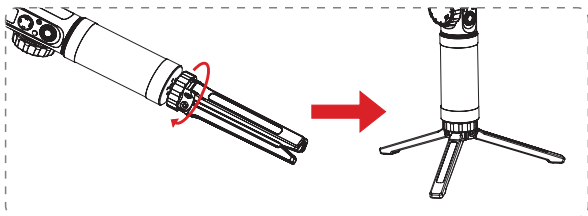

Installing Camera

1. Loosen mounting plate thumb screw, then press and hold the safety lock while sliding out the quick release plate (to the opposite direction of the arrow mark on it).

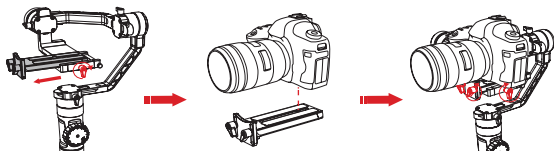

2. Install the lens to quick release plate, then tighten the 1/4" screw at its bottom (as shown above)
3. Slide in the quick release plate installed with the camera following the direction of the arrow mark on camera mounting plate, then tighten the thumb screw to finish the installation of the quick release plate.
4. Loosen the screw on lens support and adjust the support to keep the lens firm and stabilized, then tighten the screw.

⚠ Note: Do not power on stabilizer before finishing the camera installation. Please hold the camera stable during the whole process in case of any malfunctioned rotation.

Connecting Camera Control Cable

In the case of Canon camera, connect the control cable to the port on the tilt motor axis with the Micro USB end, and then the other end to the left-side port on the camera.

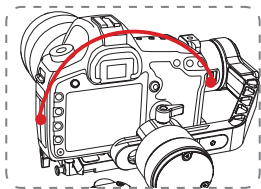

⚠ Please make sure the stabilizer is powered off or in standby mode when connecting the camera control cable in case of malfunctioned rotation.

Zhiyun Camera Control Cable Function Table

Camera brand	Canon		Nikon	Sony		Panasonic
Camera model	EOS series with Mini USB interface	EOS series with Micro USB interface	D850 and some of later DSLR	Sony cameras with MULTI interface		GH3/GH4/GH5
Camera control cable model	ZW-Mini-002	ZW-Micro-002		ZW-MULTI-001	ZW-MULTI-002	ZW-CTIA-002
Camera control cable interface	Micro USB to Mini USB	Micro USB to Micro USB		Micro USB to MULTI USB		Micro USB to CTIA
Photo	√	√		√	√	√
Video	√	√		√	√	√
Real-time preview	√	√		×	×	×
AV	√	√		×	×	×
TV	√	√		×	×	×
ISO	√	√		×	×	×
EV	√	√		×	×	×
Zoom	×	×		√	√	×
AF	√	√		×	×	√
Manual follow focus	√	√		×	×	×
Camera charging	×	×		×	√	×
Standard camera control cable	√	√		×	√	√

*Support to Nikon cameras requires firmware v1.73 or later. Please refer to page 34 for firmware upgrade.

- ⚠ Please make sure the camera is properly mounted and balanced, otherwise the stabilizer may fail to start or operate normally.**

Level Adjustment on Tilt Axis

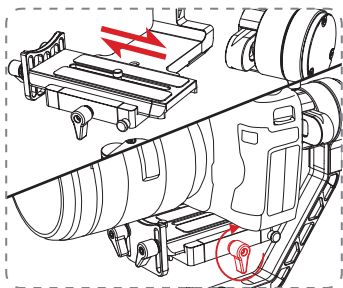

Loosen the thumb screw on the quick release plate so that it can slide forward or backward.

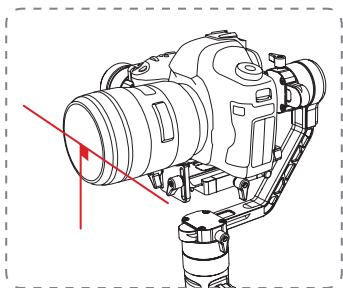

Hold the horizontal arm on the tilt axis with one hand and adjust the position of the camera to find a level balance where the camera can stay still and almost level with its lens facing front, complete this step by tightening up the camera mounting thumb screw.

⚠ The balance status of the stabilizer will greatly affect the run time.

Balance Adjustment on Tilt Axis

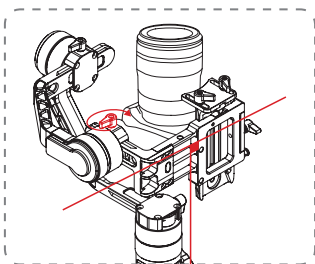

Loosen the thumb screw (rotate about 3 times); Adjust the tilt axis until the camera can stay still with the lens facing up (i.e. the camera stays still and vertical to the ground), complete this step by tightening up thumb screw.

Balance Adjustment on Roll Axis

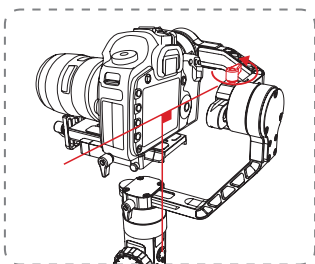

Loosen the thumb screw (rotate about 3 times); Adjust the tilt axis until the camera can stay still with the lens facing up (i.e. the camera stays still and vertical to the ground), complete this step by tightening up thumb screw.

Balance Adjustment on Pan Axis

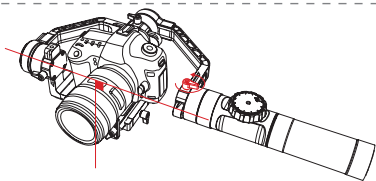

Loosen the thumb screw on the pan axis. Adjust the pan axis until the camera can stay still while keeping the vertical arm level when turned to the right/left side. Complete balance adjustment by tightening up all thumb screws.

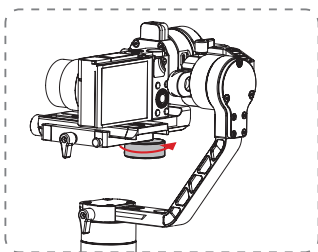

- ⚡ If the camera installed is too light that it's impossible to achieve balanced adjustment, please purchase the dedicated counterweight (100g) provided by ZHIYUN and install it under the camera mounting plate to finish balance installation.

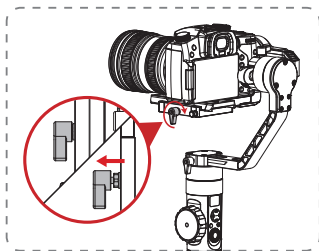

💡 If the camera hinders the rotation of the screw, please pull out the screw before rotating.

Control Panel Description

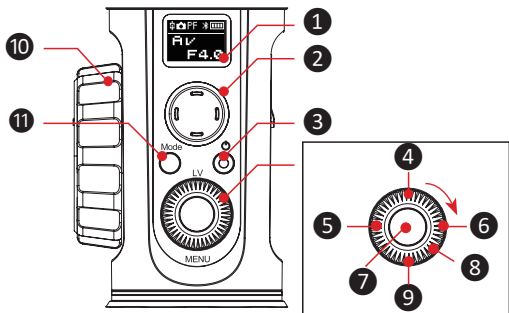
**1 OLED Display**

Stabilizer status and camera parameters display (see more on page 20).

2 Joystick

Four-way direction control of the camera/lens.

3 ON/OFF&Video*

- Long press for 3 seconds to power on/off.
- Single press to start/end video recording.

4 Real-time Preview*

Single press the button to enter the real-time preview mode.

5 Left*

- In main screen, single press to return to previous option.
- In menu screen, single press to return to previous screen.

6 Right*

- In main screen, single press to move to next option.
- In menu screen, single press to confirm selection.

7 Shutter Release*

- Halfway press the button to activate auto focus.
- Full press the button to take single shots.

8 Dial*

- In main screen, rotate the dial to adjust camera parameters.
- In menu screen, rotate the dial to switch between options.

9 Menu

Single press to enter or exit the menu.

10 Follow Focus Controller*

Rotate the controller to adjust the focal length in real time and realize follow focus control.

11 Mode

- Press for 1 second to enter or exit standby mode.
- Single press to switch between pan following and locking mode.
- Double press to switch between following and POV mode
- Triple press to realize 180° rotation on pan axis but stay in the current mode

- Quadruple press to reset tilt axis and roll axis position

“*” marked functions are only available for Canon and Nikon cameras properly connected to the stabilizer. See more at Zhiyun Camera Control Cable Function Table on page 10.

ZHIYUN- Panasonic Camera Control Function Description

Please refer to the instruction on Camera Control Cable Configuration on page 23 to choose the right option for your camera.

1. Shutter release: Halfway press ⑦ “Shutter Release” button to realize auto focus and take single shots.
2. Video recording: Single press ③ “ON/OFF&Video” button to start or end video recording.

ZHIYUN-Sony Camera Control Function Description





Please refer to the instruction on Camera Control Cable Configuration on page 23 to choose the right option for your camera.

1. Shutter release: Fully press ⑦ “Shutter Release” button to realize auto focus and take single shots.
2. Video recording: Single press ③ “ON/OFF&Video” button to start or end video recording.
3. Zooming: Press ⑤ “Left” button or ⑥ “Right” button to control the focal length.







Note: The non-motor-driven lens does not support optical zoom (recommended motor-driven lens: E PZ 18-105mm F4 GOSS, E PZ 16-50mm F3.6-5.6 OSS).

- ▲ 1. For Sony and Panasonic mirrorless camera with EVF, Real-time Preview is not needed.
- 2. When mounting a Sony camera to the stabilizer, make sure to power on the stabilizer before the camera, otherwise the stabilizer may fail to control the camera.
- 3. When powering on the stabilizer, please hold the camera with one hand in case of malfunctioned rotation.
- 4. When powering on, avoid shaking of the stabilizer which may lead to start-up failure.

OLED Display Description

	Display screen for camera params setting
	
	Display screen for stabilizer modes (camera params setting unavailable)
	
	Menu screen

Icon Description

	Camera Connection Status
	Photo Mode
	Video Mode
	Bluetooth Connection
	Battery Level (stabilizer)
PF	Pan Following Mode
POV	Point of View Mode
F	Following Mode
L	Locking Mode
V	Vortex Mode
AV	Aperture Value
TV	Time Value
ISO	ISO
	EV

Crane 2 - Canon Controllability Table

Options Camera Mode	Photo	Video	AV	TV	ISO	EV
AV (A)	√	√	√	×	√	√
TV (S)	√	√	×	√	√	√
M	√	√	√	√	√	√
P	√	√	×	×	√	√

Note: For Canon 5D4, the EV can be adjusted by setting iso "AUTO" while the Mode Dial is set to "M". Canon cameras, under real-time preview, can realize focus control.

Menu Option Description

motor (Motor torque settings)	low	Low-torque		
	medium	Medium-torque		
	high	High-torque		
camera (Camera Control Cable Settings)	close	Close interface		
	canon	Canon camera		
	nikon	Nikon camera		
	sony	Sony camera	yes	Power on
			no	Power off
panaso	Panasonic camera			
wheel (Follow Focus Wheel Settings)	sensi (Sensitivity)	low	Low sensitivity	
		medium	Medium sensitivity	
		high	High sensitivity	
	ABpoint ¹	A	Mark the current wheel position as A point	
		B	Mark the current wheel position as B point	
		clear	Clear AB points	
	priority (Priority on Wheel)	handle	Prioritize handle control	
		external	Prioritize external control ²	
		off	Disable handle wheel	
reverse	Control the wheel in a reverse direction			
joystick (Joystick settings)	reverse	vertical	joystick in vertical direction	
		horizontal	joystick in horizontal direction	
calibration (Calibration settings)	yes	Enter six-side calibration		
	no	Exit calibration settings		
angle (Fine-tuning on motor angle)	pitch	Fine tune on tilt axis motor		
	roll	Fine tune on roll axis motor		
about	Information on firmware versions			

💡 “1” AB point settings are only available when connecting to Zhiyun Servo Follow Focus correctly;

“2” External control refers to the Bluetooth or cable controls that are external to the handle.

Motor Force Adjustment

The motor force of the stabilizer needs to be adjusted (3 levels) to adapt the stabilizer to cameras and lens of different weight for ideal use.

• motor
camera
wheel

1. Single press Menu and rotate the dial to “motor”, then press right to enter the “motor” setting.

• low
medium
high

2. Rotate the dial to choose the appropriate motor force (3 levels), press right to confirm the option.

Motor Force	Weight Capacity	Compatible Camera & Lens Examples
Low	Light	Sony A7S Camera+SEL35F28Z Lens
Medium (default)	Medium	Canon 5D Camera+EF 50mm F/1.8 II Lens
High	Heavy	Canon 5D Camera+EF 24-70mm f/2.8 L II USM Lens

⚠ Either the motor force is set too high or too low (unmatched with weight capacity) can lead to camera shake and affect normal use of the stabilizer.

Camera Control Cable Configuration

motor

• camera
wheel

1. Single press Menu and rotate the dial to “camera”, then press right to enter the “camera” setting.

• close

| canon
sony

2. Rotate the dial to choose your camera brand, press right to confirm the option and restart the stabilizer to finish.

💡 If there is no option to match your camera brand or there is no need to connect your camera, choose “Close”.

- ⚠️ 1. After re-setting the parameters in Menu, the stabilizer will enter standby mode, please long press mode button to activate the camera.
2. Some Sony cameras do not support charging while using. Please turn off Power Output in Sony options.

Control Mode Description (for firmware V1.72, V1.73, V1.74 and V1.75)

•Single Press of Mode Button



Switch between pan following mode and locking mode.

•Double Press of Mode Button



Switch between following mode and POV mode.

Control Mode Description(for firmware V1.76、V1.77)

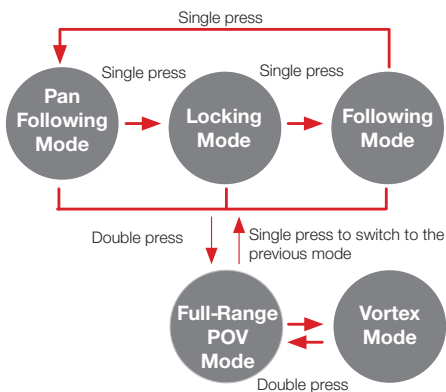

·Triple Press of Mode Button

The pan axis rotates 180° without changing the current mode (not available in locking mode).

Quadruple Press of Mode Button

Reset the position of the tilt axis motor and the roll axis motor of the stabilizer.

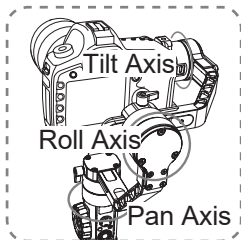
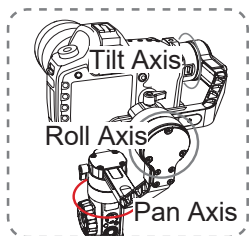

Pan Following Mode (PF):

The camera pans left/right following the movement of the stabilizer while the tilt and roll axes are locked. Push the joystick up/down allows manual control of the tilt axis.

Locking Mode (L):

This mode locks movement of all three axes to keep the camera fixed on a shooting direction. Push the joystick up/down and left/right allows manual control of the tilt axis and pan axis.

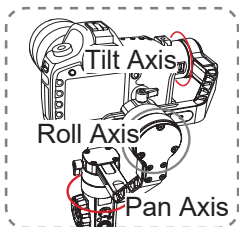
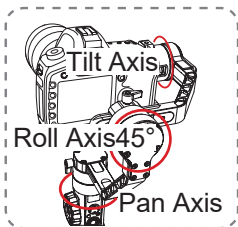

Point of View mode (POV):

The mode allows the camera to roll left/right at a max. angle of 45° , and pan left/right or tilt up/down with unlimited 360° rotation following the movement of the gimbal handle.

Following Mode (F):

The camera pans and tilts following the movement of the stabilizer. Push the joystick left/right allows manual control of the roll axis.

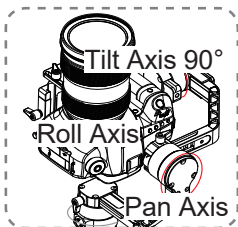

Vortex Mode (V) :

Tilt axis motor rotates 90° following the movement of the handle while the roll axis motor follows

the movement of the handle as well. Push the joystick right/left to rotate the pan axis.

Bottom up Mode Operation

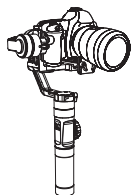

Top Down Mode

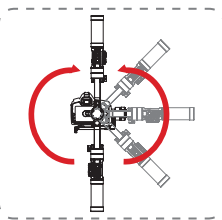

Bottom Up Mode

Please ensure balanced installation of the camera under top down mode and do not rotate or shake the handle while initiating the bottom up mode (as seen in graph).

⚠ Whether the bottom up mode is successfully initiated is affected by the size and the balance of the camera. Some cameras may need to be bottom up before initiating the bottom up mode.

Manual Positioning

Under pan following mode and locking mode, you can manually rotate the camera to a certain angle, then loosen your grip and the camera position will be fixed. Under pan following mode, you can manually adjust the angle of tilt axis. Under locking mode, you can manually adjust the angle of pan axis and tilt axis.

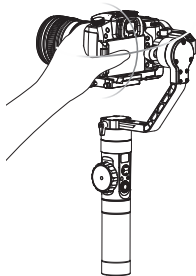

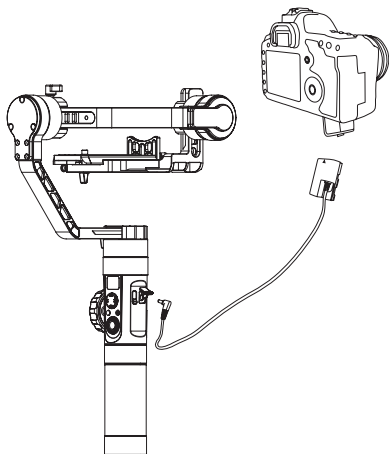
DC 8.0 V Power Outlet Usage

The DC 8.0 V power outlet on the side of the stabilizer can be used for charging the Canon 5D camera through a DC connector DR-E6 (purchase separately).

Charging 5D3/5D4 camera:

Powering on:

1. First, connect the power input end of the connector to the DC 8.0V power outlet, then connect the other end of the connector to the camera.
2. Install the camera to the stabilizer and power on the stabilizer, then start up the camera.

Powering off:

First, power off the camera, then unplug the connector from the stabilizer.

Charging 5D2 camera:

Powering on:

1. Start up the stabilizer, long press the mode button to enter standby mode.
2. Connect the power input end of the connector to the DC 8.0V power outlet, then connect the other end of the connector to the camera.
3. Install the camera to the stabilizer and adjust gimbal balance.
4. Power on the camera and long press mode button to activate the stabilizer.

Powering off:

First, power off the camera, then unplug the connector from the stabilizer.

- ▲ 1. Original Canon DR-E6 DC power connector is recommended; Please follow the procedure herein in case of accidents.**
- 2. Please power on/off the camera in accordance with the procedure, otherwise the camera may fail to start.**

APP Download and Installation



Download the APP from ZHIYUN's official website www.ZHIYUN-TECH.com, or by directly scanning the QR code on the left (Android 5.0 above or iOS9.0 above required) to download. iOS or Android users can download the APP by searching "ZY Play" in APP Store.

The ZHIYUN APP is subject to regular update, try out now to discover more functions.

Connecting the Stabilizer to Smartphone

1. Power on the stabilizer and turn on Bluetooth on the phone;
2. Open "ZY Play" App, and click "Please connect device". Choose your stabilizer to connect.

Overview of Main Functions



When do you need to calibrate the stabilizer?

Please calibrate the stabilizer when necessary to ensure normal use.

When	How
<ul style="list-style-type: none"> a) Slight deviation is found in the tilt angle of the camera in level position after startup. b) Slight deviation is found in the roll angle of the camera in level position after startup. c) Frequent small angle correction is found when the camera is in level position while the stabilizer stays still. 	Initialize the stabilizer
<ul style="list-style-type: none"> a) Slight deviation is still found in level position after the initialization of the stabilizer. b) Stabilizer unused for a long time. c) Too large temperature difference between operation environments. 	Conduct six-side calibration
Slight deviation is still found in the tilt or roll angle of the camera in level position after the initialization and six-side calibration of the stabilizer.	Fine tune motor force

Initialization Method

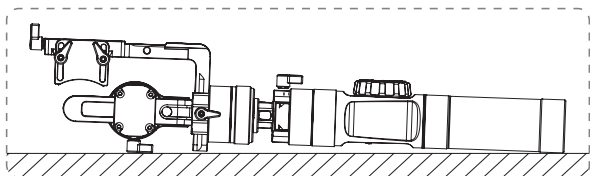

1. Correctly install the batteries.
 2. Hold the camera mounting plate with one hand, long press the power button to start up the stabilizer; Long press the Mode button to enter the standby mode while holding the camera mounting plate through the whole process in case of start-up failure.
 3. Put the stabilizer still on a table surface, wait for about 30 sec., and the stabilizer will automatically complete initialization.
- ▲ If the angle deviation still persists after the initialization, please try again following the procedure.**

Six-side Calibration

Six-side calibration

1. Power on the stabilizer and enter the standby mode, press menu, rotate the dial to “calibration” option, press Right to enter the option.
2. As seen below, conduct the six-side calibration following the 6 steps shown in the graphs, finish by pressing any button to exit the menu.

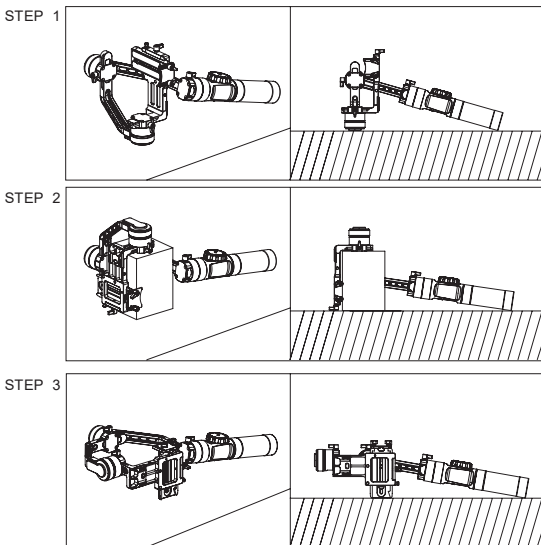

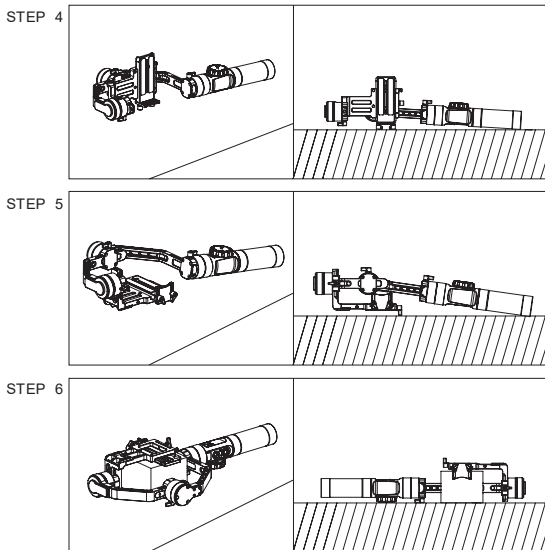

Six-side calibration through APP

Connect the stabilizer to “ZY Play”. Enter “Calibration” and finish the six-side calibration following the APP instruction.

- 💡 Six-side calibration is to make all six sides of the camera mounting plate vertical to the level surface.

Motor Fine-tuning

Fine tune the motor through stabilizer:

1. Power on the stabilizer and enter standby mode, then rotate the dial and press right to enter the “angle” option; Adjust the value of the tilt and roll axis angle to your actual needs.
2. Fine tune the motor through APP:
3. Connect the stabilizer to "ZY Play". Enter “Gimbal Settings”, and adjust the value of the tilt and roll axis angle to your actual needs.

Firmware Upgrade

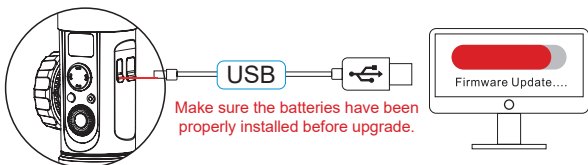

Connect the stabilizer to your computer via Micro USB cable to get ready for the firmware upgrade and calibration.

1. Visit ZHIYUN's official website: www.zhiyun-tech.com Click “DOWNLOAD” and find the Firmware Upgrade Tutorial package, then download the driver, calibration tool and latest firmware corresponding to your stabilizer. (USB driver installation is not needed for Mac and WIN 10 system).
2. Connect the stabilizer to your computer via Micro USB cable, power on the stabilizer and finish the installation of the driver.
3. Power on the stabilizer and long press mode button to enter standby mode.
4. Enter the downloaded “Zhiyun Gimbal Tools” and upgrade firmware following the instructions indicated in the Firmware Upgrade Tutorial.

ZW-B03 Motion Sensor Remote Control with Follow Focus (sold separately)

ZW-B03 Motion Sensor Remote Control with Follow Focus is designed exclusively for Crane 2. Through Bluetooth or cable connection to Crane 2, you can realize comprehensive control on Crane 2. The G-Mode and Motion mode exclusive to this product can bring more inspiration to your operation on Crane 2.

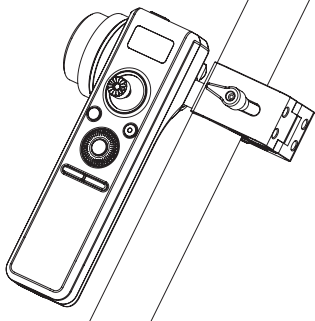
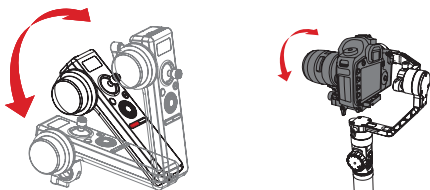

ZW-B02 Remote Controller (sold separately)

ZW-B02 Remote Controller is small and portable. You can install on the Extended Handle easily and realize basic control on Crane 2.

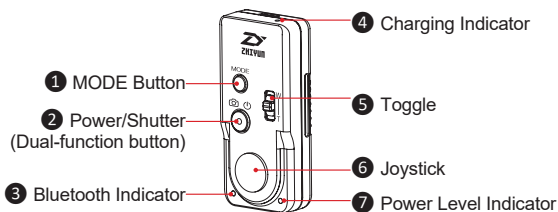

CRANE-EH002 Crane 2 Extended Handle (sold separately)

Operating Crane 2 with the Extended Handle is less physically demanding and more flexible with both hands on.

Top down gesture

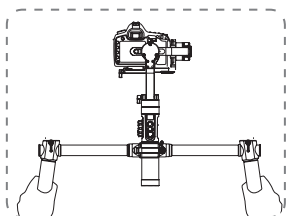

Bottom up gesture

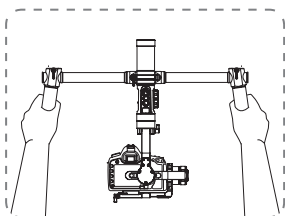

5.5" Mini Camera Monitor (sold separately)

5.5" Mini Camera Monitor ("Monitor") supports 4K HDMI input. With the 8bit IPS LCD screen, the Monitor supports 1920*1080 resolution. The Monitor features accurate color reproduction and a wide viewing angle. It is also packed with powerful functions such as peaking focus assist/screen rotation/safe area, etc. The Monitor comes with a dedicated thin HDMI cable, which is perfect for connecting the stabilizer. Designed exclusively for stabilizers, 5.5" Mini Camera Monitor enhances your experience in using the stabilizer.

1/4 Thread Metal Holder with Flexible Pipe (sold separately)

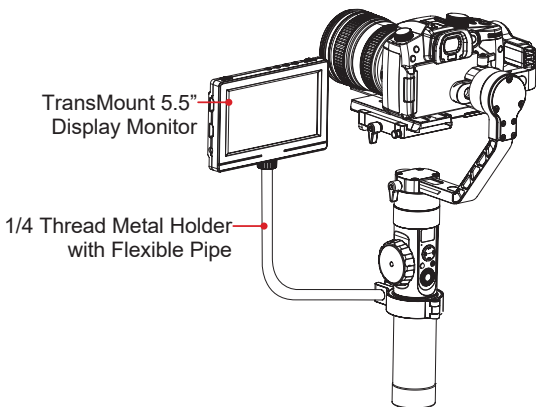

The Flexible Pipe can be installed on Crane 2 handle easily and its 1/4 thread hole can be mounted to 5.5" Mini Camera Monitor, supplement lamps or other camera equipment. The flexible pipe enables angle adjustment easily.

Mini Dual Handle Grip (sold separately)

Designed for Crane series, Mini Dual Handle Grip enables a more convenient operation on Crane 2. Using the Grip allows you to hold Crane 2 easily in different shooting environment and get a smooth sports footage. The Grip can be mounted to a monitor and a supplement lamp, which give you more possibilities in creating footage.

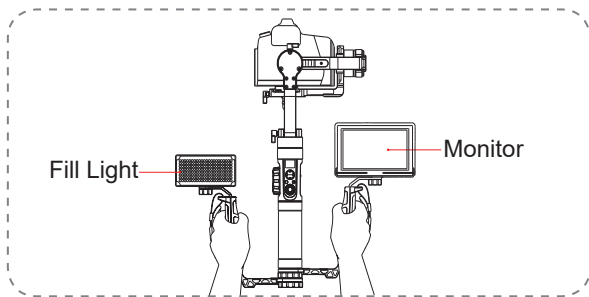
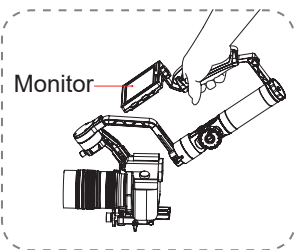
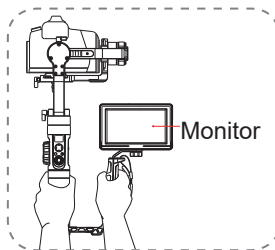

Crane 2 Shoulder Bracket (sold separately)

This bracket is tailored for Crane 2. Its bumper connects seamlessly to Crane 2 which keeps your hands free during shooting and satisfies the need of long-time physical demanding shooting.

Crane 2 can rest on the

Bracket when the shooting temporarily pauses. The Bracket is widely used in outdoors filming, wedding filming, live-streaming and movie making.



Telescopic Monopod (sold separately)

Zhiyun Telescopic Monopod is designed to optimize Crane series. Mounted to Crane 2, it allows you to move Crane 2 with greater flexibility while saving effort.



Product model: CRA02

	Min.	Standard	Max.	Remarks
Input Vol.	9.8V	11.1V	12.6V	
Operation Current	110mA		6000mA	
Operation Temperature	-10°C	25°C	45°C	
Operation Time	12h		18h	Tested under static operation after proper balancing
Charging Time		2.5h		Charging current 2400mA
Weight		1250g		Excluding batteries
Tilt Angle Range	-135°		+185°	
Roll Angle Range		360°		Unlimited rotation
Pan Angle Range		360°		Unlimited rotation
Following Deviation in Static State	±0.01°		±0.03°	
Following Deviation in Motion State	±0.05°		±0.1°	
Payload	500g		3200g	
Compatible Camera Sizes	The max. horizontal length from the point of camera gravity to the roll axis is 90mm, from the 1/4" threaded hole to tilt axis 90mm, and from gravity point to quick release plate 65mm.			
Product Dimension	210 X 118 X 450mm			

Thank you for purchasing ZHIYUN Crane 2. The information contained herein affects your safety, legitimate rights and obligations. Please read this instruction carefully to ensure proper configuration before use. Failure to read and follow this instruction and warnings herein may result in serious injury to you or bystanders, or damage to your device or property. Guilin Zhishen Information Technology Co., Ltd reserves all rights for final explanation on this instruction and other documents related to Crane 2. The information is subject to update without notice. Please visit www.zhiyun-tech.com to obtain the latest product information.

By using this product, you hereby signify that you have read this document carefully and that you understand and agree to abide by the terms and conditions herein. You agree that you are solely responsible for your own conduct while using this product, and for any consequences thereof. You agree to use this product only for purposes that are proper and in accordance with all terms, precautions, practices, policies and guidelines ZHIYUN has made and may make available.

ZHIYUN accepts no liability for damage, injury or any legal responsibility incurred directly or indirectly from the use of this product. Users shall observe safe and lawful practices including, but not limited to, those set forth herein.

ZHIYUN is the trademark of Guilin Zhishen Information Technology Co., Ltd. (hereinafter referred to as “ZHIYUN” or “ZHIYUN TECH”) and its affiliates. All product names or marks referred to hereunder are trademarks or registered trademarks of their respective holders.

Reading Tips

Legends:  Hints and tips
 Important.

Warnings

Crane 2 is a sophisticated product. It must be operated with caution and safe knowledge and requires some basic hands-on ability. Read the ENTIRE instruction to be familiar with the features of this product before use. This product is not intended for use by children. DO NOT use with incompatible components or in any way otherwise as mentioned or instructed in the product documents provided by ZHIYUN. The instruction herein contain instructions for safety, operation and maintenance. It is essential to read and follow all of the instructions and warnings in the instruction, prior to assembly, setup or use, in order to operate the product correctly and avoid damage or serious injury.

Safe Operation Guidelines

■ CAUTION:

1. Crane 2 is a high-precision control device. Damage may be caused to Crane 2 if it is dropped or subject to external force, and this may result in malfunction.
2. Make sure the rotation of the gimbal axes is not blocked by external force when Crane 2 is turned on.
3. Crane 2 is not waterproof. Prevent contacts of any kind of liquid or cleaner with Crane 2. It is recommended to use dry cloth for cleaning.
4. Protect Crane 2 from dust and sand during use.

■ WARNING

To avoid fire, serious injury, and property damage, observe the following safety guidelines when using, charging, or storing your batteries.

Battery Use

1. Prevent the batteries to come into contact with any kind of liquid. Do not leave batteries out in the rain or near a source of moisture. Do not drop the battery into water. If the inside of the battery comes into contact with water, chemical decomposition may occur, potentially resulting in the battery catching on fire, and may even lead to an explosion.
2. If the battery falls into water with the stabilizer during use, take it out immediately and put it in a safe and open area. Maintain a safe distance from the battery until it is completely dry. Never use the battery again, and dispose

of the battery properly as described in the Battery Disposal section below.

3. If the battery catches fire, use water, water spray, sand, fire blanket, dry powder, or carbon dioxide fire extinguisher immediately to put out the fire. Battery-caused fire may lead to explosion. Please extinct the fire by applying the methods recommended above according to the actual situation.
4. Never use non-ZHIYUN batteries. If replacement or backup is needed, please purchase new batteries from ZHIYUN's official website or authorized channels. ZHIYUN takes no responsibility for any damage caused by non-ZHIYUN batteries.
5. Never use or charge swollen, leaky, or damaged batteries. Never use or charge if the battery smells, or overheats (exceeding maximum temperature of 160°F / 71°C). If your batteries are abnormal, contact ZHIYUN or a ZHIYUN authorized dealer for further assistance.
6. The battery should be used within the temperature range from -10°C to 45°C . Use of battery in environments above 45°C may lead to a fire or explosion. Use of battery below -10°C may lead to serious battery damage.
7. Do not use the battery in strong electrostatic or electromagnetic environments. Otherwise, the battery protection board may malfunction.
8. Do not disassemble or use any sharp object to puncture the battery in any way. Otherwise, the battery may leak, catch fire or explode.

9. Do not mechanically strike, crush, or throw the battery. Do not place heavy objects on the battery or charger.
10. Electrolytes inside the battery are highly corrosive. In case of accidental contact of any electrolytes with your skin or eyes, rinse immediately with water for at least 15 minutes and seek medical advice as soon as possible.
11. Do not use the battery if it has been involved in a crash or heavy impact.
12. Do not heat the battery and never put the battery in a microwave oven or in a pressurized container.
13. Do not place the battery on a conductive surface (such as a metal desk surface, eye-glasses, watch, jewelry, etc.)
14. Prevent use of wires or other metal objects that could cause positive and negative short-circuit to the battery.
15. If the battery terminal is dirty, wipe it with a clean, dry cloth. Otherwise it will cause a bad battery connection, which may result in energy loss or charging failure.

Battery Charging

1. The battery will automatically stop charging once it is full. Please disconnect the battery and the charger when fully charged.
2. Do not attach the batteries to a wall outlet or car charger socket directly. Always use a ZHIYUN approved adapter for charging.

ZHIYUN takes no responsibility if the battery is charged using a non-ZHIYUN charger.

3. Do not put the battery and charger near flammable materials or on flammable surfaces (such as carpet or wood). Never leave the battery unattended during charging to prevent any accident.
4. Do not charge the battery immediately after use, because the battery temperature may be too high. Do not charge the battery until it cools down to normal room temperature. Charging the battery with its temperature over 45°C or lower than 0°C may lead to leakage, overheating, or damage.
5. Examine the charger before use, make sure there is no damage to the enclosure, cord, plug, or other parts. Never use a damaged charger. Do not clean the charger with any liquid containing alcohol or other flammable solvents. Disconnect the charger when not in use.

Battery Storage

1. Keep batteries out of the reach of children and pets.
2. Do not leave the battery near heat sources such as a furnace or heater, or inside of a vehicle on hot days. Never expose the battery in any environment with temperature of over 60°C . The ideal storage temperature is 22°C - 28°C .
3. Store batteries in a dry environment.
4. Do not leave the battery unused for too long after it has been completely discharged to

prevent over-discharge of battery which may result in battery damage and permanent failure.

Battery Maintenance

1. Do not over-charge or over-discharge the battery, which will damage the battery;
2. The battery performance will be affected for not being used for a long time;
3. Never use the battery when the temperature is too high or too low;
4. Do not store the battery in any environment with a temperature of over 60°C .

Battery Disposal

1. Please fully discharge the battery before putting it in the designated recycling bin. Batteries contain hazardous constituents and it is forbidden to put the battery in general waste bin. For related details please abide by the local laws and regulations on battery recycling and disposal.
2. If the battery cannot be fully discharged, never put it in battery recycling bin. Please contact battery recycling companies for a proper solution.

Warranty Period

1. Customers are entitled to replacement or free repair service in case of quality defect(s) found in the product within 15 days upon receipt of the product.
2. Customers are entitled to free repair service from ZHIYUN for any product proven defective in material or workmanship that results in product failure during normal consumer usage and conditions within the valid warranty period, which is 24 months counting from the date of delivery.
3. Some states or countries do not allow limitations on how long an implied warranty lasts, so the above warranty term may not apply to you.

This warranty does not apply to the followings

1. Products subjected to unauthorized repair, misuse, collision, neglect, mishandling, soaking, accident, and unauthorized alteration.
2. Products subjected to improper use or whose labels or security tags have been torn off or altered.
3. Products whose warranty has expired.
4. Products damaged due to force majeure, such as fire, flood, lightening, etc.

Warranty Claim Procedure

1. If failure or any problem occurs to your product after purchase, please contact a local agent for assistant, or you can always contact ZHIYUN's customer service through email at service@zhiyun-tech.com or website at www.zhiyun-tech.com.
2. Your local agent or ZHIYUN's customer service will guide you through the whole service procedure regarding any product issue or problem you have encountered. ZHIYUN reserves the right to reexamine damaged or returned products.

Customer information

Customer Name :

Contact No :

Address :

Sales Information

Sales Date :

Prod. Serial No :

Dealer

Contact No :

#1 Maintenance Record

Service Date :

Signature of Repairman :

Cause of Problem :

Service Result : Solved

Unsolved

Refunded(Replaced)

Contact Card



Website



Weibo



Vimeo



Google+



Facebook
(Zhiyun Support)



Facebook
(Zhiyun Tech)



Youku



Youtube



Wechat



Instagram

Tel: 86 400 900 6868

USA Hotline: +1 808-319-6137, 9:00-18:00 GMT-7, Mon-Fri

Europe Hotline: +49 (0)6101 8132 180, 10:00-17:00 GMT+1, Mon-Fri

Email: service@zhiyun-tech.com

Website: www.zhiyun-tech.com

Address: 009 Huangtong Road, Tieshan Industrial Zone, Qixing District, Guilin, 541004, Guangxi, China.

Certificate of Quality

This product is confirmed to meet quality standards and permitted for sale after strict inspection.

QC Inspector: _____



Please download the latest version from
www.zhiyun-tech.com

This document is subject to change.

ZHIYUN™ is a trademark of ZHISHEN.

Copyright © 2020 ZHISHEN. All rights reserved.

ZHIYUN-TECH.COM